



XMRX8

User manual



Content

1. Introduction.....	1
2. Structure design.....	2
2.1 Front view.....	2
2.2 Back view.....	3
3. Basic Operations	4
3.1 Live view window.....	4
3.2 Main menu.....	4
4. Device using.....	10

1. Introduction

BWC-R1 is an intelligent body worn camera specifically designed for Law Enforcement. The camera features real time HD video, 1080P recording, support built-in 4G, WIFI and GPS function, and a high resolution still image capture visible on the LCD screen for instant playback, with wide angle; The rugged design is resilient to withstand demanding work environments faced by law enforcement officers, corrections, military and security detail.

Package Contents

- * Body worn camera
- * USB cable
- * USB power adapter
- * CD with manual and software
- * Universal metal clip

2. Structure design

2.1 Front view

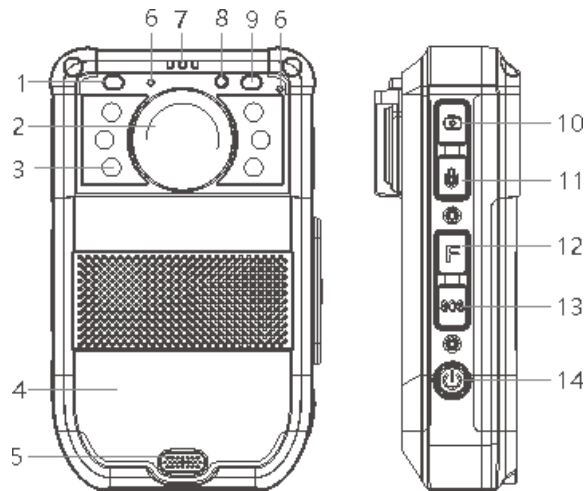

Item	Name	Description
1	IR sensor	The sensor will detect the brightness of the environment, and then activate the IR light and switch to night vision mode.
2	Camera Lens	Full HD wide angle camera lens
3	IR light	Record clear image in HD in low light situations. 10 meters visible.
4	Battery cover	Remove this cover, you can take out the battery for replacement
5	Cover lock	Press the lock and remove the cover, and then you can take it out.
6	Microphone	Capture the environment voice during recording, and communicate with the center server.
7	Working indicator	Red blinking means video recording, yellow blinking means audio recording, solid green means standby or preview mode. Blue light means network transmission.
8	Laser light	Pinpointing an object from a distance, solid or blinking mode
9	Lighting	Short press the F button to enable the light for auxiliary lighting.
10	Snapshot	Press this button to start capture the snapshots, even during video recording mode.
11	Audio REC button	Press the button to start the audio recording only.
12	Muti-functional button	You can define this function of this button, the default one is enable withe light.
13	SOS button	Press this button to send an alert info to the center server.
14	ON/OFF button	Short press the button to open or close the lighting, long press it to power on or power off.

2.2 Back view

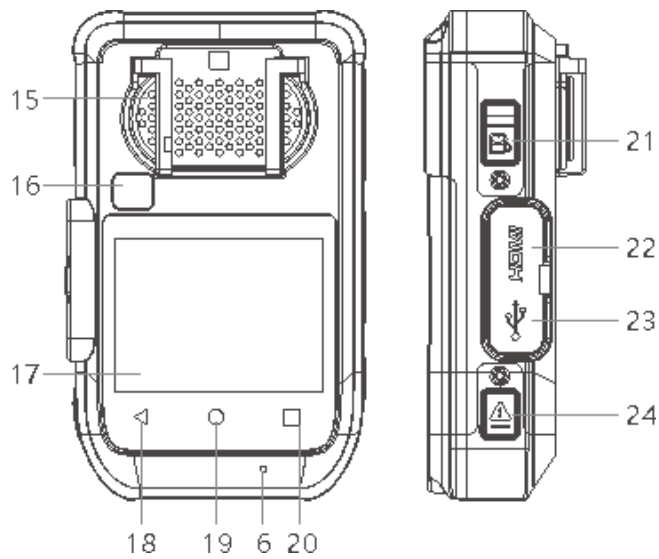

Item	Name	Description
15	Speaker	It's the speaker to audio playback and voice report.
16	Screen off sensor	When the sensor detected, it will turn off the screen automatically
17	Touch screen	It's a touch screen for operation
18	Return key	When you do the operation, press this icon to return to the previous interface
19	Home key	Press this icon to make the operation back to the home interface
20	Camera view	Press this icon to make the camera enter into the camera preview mode
21	Video REC button	Press this button to start the video recording
22	Mini HDMI port	Connect to the external HD camera
23	USB port	Connect USB cable for charging or connection to PC.
24	Flag button	Press this button during recording, it will make the recorded video as a marked video file.

3.1 Live view window

The body worn camera LCD screen is a small monitor to display various camera information and operation status.

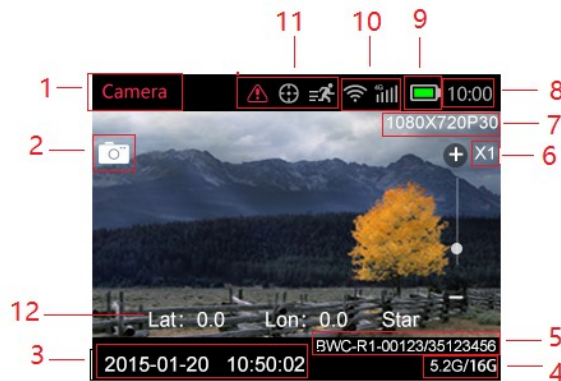

Item	Name	Description
1	Video recording icon	Yellow icon means video recording is working.
2	Snapshot icon	Yellow icon means snapshot success.
3	Date/Time	The current date/time
4	Storage info	Display the capacity and remaining size of the storage
5	ID information	The officer ID and Device ID of this camera
6	Zoom in/out	The Zoom in and zoom out info
7	Recording resolution	The resolution that camera will recording
8	Time	The current time from the Android system
9	Battery status	The current status of the battery
10	Network status	It will display the WIFI and 4G network status if it's enabled
11	Function icon	It will show the feature icon, such as motion detect, flag icon, pointing and so on
12	GPS Info	It will show the latitude and longitude info of the camera.

3.2 Main menu

In preview mode, press home key to enter into main menu interface, you will see the interface as follow:

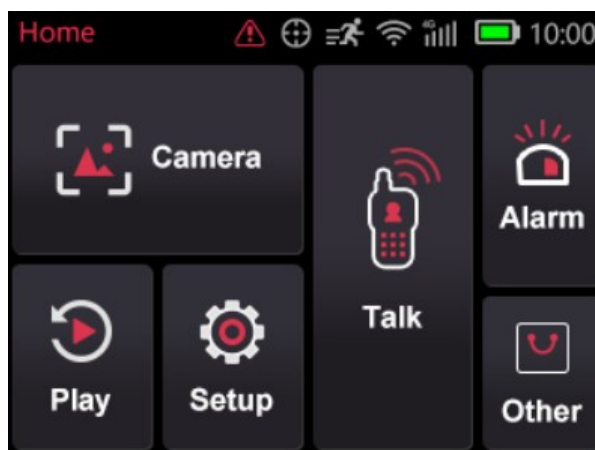

1	Camera	Enter into the live view of the camera
2	Play	Playback the local video, audio and images.
3	Setup	Setup all the parameters of the camera
4	Talk	Start the intercom function with other camera or center server, video and audio call.
5	Alarm	Check the SMS or picture message sent from center server
6	Other	Some other functions of the camera, such as app, hot spot, pointing and so on

Video setup and photo setup: Click the icon “” to login the video and photo setup

ID	Menu	Options
1	Video resolution	1080P30,,720P30
2	Video quality	High, Low, Medium
3	Segment time	Auto, 10min, 20min, 30min
7	Photo pixel	5M, 8M, 10M, 12M, 16M, 21M, 32M
8	Snapshot	1PCS,2 PCS,3 PCS,5 PCS
9	Snapshot timing	ON/OFF, default is 000000

1. Video resolution

The body worn camera offers five different recording resolutions. Resolution and frame rate options feature a proper balance between video quality and maximizing amount of video stored.

Options	Display resolution	Images per second
720P30	1280*720	30
1080P30	1920*1080	30

2. Video quality

Select video quality based on the need of video recording. High means the best quality, which will encoding with big bit rate.

3. Segment time

Segment time selection defines the length of each video segment, and this option only is used for video recording, invalid for audio recording.

Sub-option: Auto, 1 minutes, 3 minutes, 5 minutes, 10 minutes, 20 minutes, 30 minutes; auto means it will create a file in almost 2GB size, and the time is about one hour, depends on the video resolution.

4. Photo pixel

The photo pixel provides options for still image resolution, 3M~41M optional.

5. Snapshot

In preview mode, Long press the snapshot button to shoot the selected number of pictures, and you can set the option as 1PCS, 2 PCS, 3 PCS, 5 PCS, 10PCS, 20PCS, 30PCS. When video recording is working, the function will not work; When video recording is working, short press snapshot button can take one single photo.

6. Snapshot timing

OFF means disable this function, and for the timing option: 30sec, 1min, 2min, 4 min, 5 min, it means every this time it will take a snapshot.

SETUP>>DEVICE

Select the “Setup”, you will enter into all the parameters configurations, the all items are as follow:

ID	Menu	Options
1	Brightness	Drag the icon to adjust
2	Screen off	30sec,1min,3min,5min,OFF
3	Screen sensor	ON,OFF
4	Vibration	ON,OFF
5	Infrared	ON, OFF
6	Infrared Power	High, Low
7	F button	Flash, sound, laser light, IR manually, playback, setup
8	Indicator light	ON, OFF

1. Brightness

Adjust the brightness of the screen, just drag the icon to adjust.

2. Screen off

Switch off the screen after a certain time if there is any operation, which will save the power consumption.

3. Screen sensor

When the option is on, and if the sensor detected, it will turn off screen automatically.

4. Vibration

When option is on, It will remind the users that the function is in use through vibration.

5. Infrared

This option means you can enable or disable the Infrared function.

6. Infrared power

There are two options for this function, high means

7. F button

You can define a function for the F button: Flash, sound, laser light, IR manually, playback, or enter into setup interface.

8. Indicator light

When the option is OFF, which means all the indicator light will be off when camera is start up, ON means it will display all the LED normally..

Media :

ID	Menu	Options
1	Post-recording	10sec, 30sec, 1min, 2min, 5min, 10min, 30min, OFF
2	Pre-recording	OFF, ON
3	Motion detect	ON, OFF
4	Security password	ON/OFF, default is 000000
5	GPS watermark	OFF, ON
6	Communication tone	Voice, beep
7	Media Volume	Drag the icon to adjust
8	Warn tone	Beep, Voice
9	Hourly notice	ON, OFF

1. Pre-recording

Pre-recording saves an additional seconds of video before the video recording button is pressed, and the additional seconds is about 30 seconds. After the option of pre-recording is enabled, the camera can not snapshot, but the snapshot will work during the video recording.

For example, we set the value(between setting the pre-recording and pressing the video recording button) as X, if $X < 30s$, the camera will store an additional video for X seconds before the video recording button is pressed, if $X \geq 30s$, the camera will store an additional video for 30 seconds before the video recording button is pressed.

2. Post-recording

Post-recording means how long the camera should continue to record after the video recording button is pressed to stop recording.

3. Motion detect

When the option is on, if there is something moving in the camera, the camera will start to recording. You can press the recording button to stop recording.

4. Security password

When this option is on, you have to type in the password if you want to playback and do configurations, the default password is:000000.

5. GPS watermark

When the option is on, the GPS info will display in the video image, even in the recorded video and streaming video.

6. Communication tone

The is option means when the two-way audio communication function is enabled, the tone is vibration or use the incall tone, and adjust the volume.

7. Media Volume

Select volume level option to increase or decrease all the volume of camera, including playback, key sound, indicate sound and so on.

8. Warning tone

There are two options, voice and beep, voice option means when the user operates camera, it will give the corresponding response, OFF, beep or voice, and it will applied to the operations as follows:

1. Start video recording;
2. Stop video recording;
3. Start audio recording;
4. Stop audio recording;
5. Power on the camera;
6. Power off the camera;
7. Low battery;
8. Inadequate storage space;

Beep option means it only beep when do the operations.

9. Hourly notice

Select to turn the hourly notice ON or OFF, it will give the voice report hourly if the switch is ON.

SETUP>>>>SEVER

ID	Menu	Options
1	Sever	Configure the server IP, port and user number.
2	Bitrate	Select different resolution and bitrate for streaming
3	Upload frequency	0~999 seconds optional

1. Server

Setup the server IP, port, and user number, make sure the camera can connect to the center server.

2. Stream bitrate

Select the bitrate for the live video streaming.

3. Upload frequency

Select the GPS upload frequency time, it means every this certain time, it will upload a GPS info to center server.

SETUP>>>>SYSTEM

ID	Menu	Options
1	WAN	OFF,ON
2	Mobile data	OFF,ON
3	Bluetooth	OFF,ON
4	Location	GPS, GPS+Beidou, Beidou
5	Offline connection	OFF,ON
6	About	Voice, beep
7	Default setting	Drag the icon to adjust

1. WAN

Enable it, so the camera can connect to WIFI network.

2. Mobile data

Only when this option is on, the 4G network can transmit the live video to center server.

3. Bluetooth

Enable the Bluetooth function, which can connect to an earphone.

4. Location

It means the frequency that camera upload the GPS data to the center server.

5. Offline connection

It means when the camera connect to PC or docking station through USB port, the camera will disconnect the wireless connection.

6. About

It will show the information of the camera, network status, firmware version, and so on.

Mark: For the internal battery, only when the voltage more than 3.5v, it can works when remove the main battery.

7. Default

When it is set as ON, the camera will auto-reboot to clear all the settings of menu, but all the playback files will still be in the camera.

4. Device using



1. Turning On the Camera

In power off status, long press  for 3 seconds, the camera will be turn on and enter into preview mode automatically. Meanwhile, the status indicator will turn green.

2. Turning off the camera



In preview mode, long press  for 3 seconds, the camera will save the current status and power off. Meanwhile, the status indicator will turn off.

3 Recording Video



In preview mode, short press  to start recording. Meanwhile, the status indicator will turn red and flash, and the recording icon will turn to red. Short press  again to stop recording, and the video will be saved in MP4 format automatically.

Remark: During video recording, can zoom in and zoom out by sliding the icon in the screen.



4 Snapshot

In preview mode, press  to take a photo; long press  to take more photos continuously, the quantity of photo can be configure in the menu. Meanwhile, the status indicator will turn red and flash, snapshot icon will turn to red. and the photo will be saved in JPG format automatically.



5 Audio recording

In preview mode, short press  to start audio recording. The recording icon display on the screen, the status indicator will turn to yellow and flash. Short press  again, the camera will stop audio recording, and the audio will be saved in WAV format automatically.

6 Playback



Click HOME key  to enter the menu interface , and then click Playback  to enter into playback interface and play the selected file

7 Make a flag for the file



In video/audio recording mode, short press flag button  to mark it as important file, the icon  will display on the top of screen. Short press key mark button  again to cancel the mark.

When playback the file, short press key mark button  to mark it as important file or cancel the mark. The name of the marked file has the characters “IMP”.



8 Parameter configuration

Click HOME key  to enter the menu interface, and click Setup icon  to enter into the parameters configure interface, you can setup all the camera parameters here, such as resolution, network settings and so on.



9 Intercom

Click HOME key  to enter the menu interface, and click Intercom icon , enter into the intercom interface, and select online users for video or voice intercom, you can finish it by sliding the end button.

10 Alarm

Click HOME key  to enter the menu, and click Alarm  to enter into the Alarm interface, you can browse the received alarm, select and check the details, open the video, the video files will be automatically associated with the alarm and marked as important documents.

11 Application

Click HOME key  to enter the menu, and click APP , enter APP interface and select the corresponding application.

12 SOS

Short press SOS button , the camera will send emergency alert to the Center management platform.

13 Reset

If the system crash and the operation is no respond, long press power button for about 10 seconds, the camera will be forced to reset

Remark: Reset operation will not cause data loss or damage, and it will not change the system settings.

1. Replace battery

- 1 Press the battery cover lock down, and do not loose it
- 2 Push the battery cover parallel to the direction of the arrow and remove it.

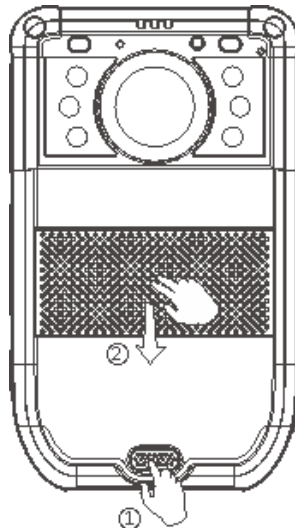

2. Charging the Battery

Remark: When you recharge the body camera, please make sure it is OFF. Also, even you don't use the camera for a long time; please recharge it every 3 months.

1.Charge the camera

Connect this camera and adapter via USB cable, and connect adapter to power supply to charge the battery. In charging status, the status indicator will turn red. Once the battery is fully charged, the status indicator will turn green.

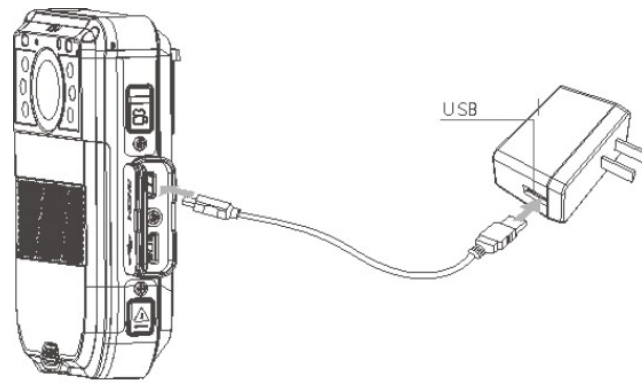

1. Charge the battery

Connect the battery charger to the power supply to charge the battery. In charging status, the status indicator will turn red. Once the battery is fully charged, the status indicator will turn green.

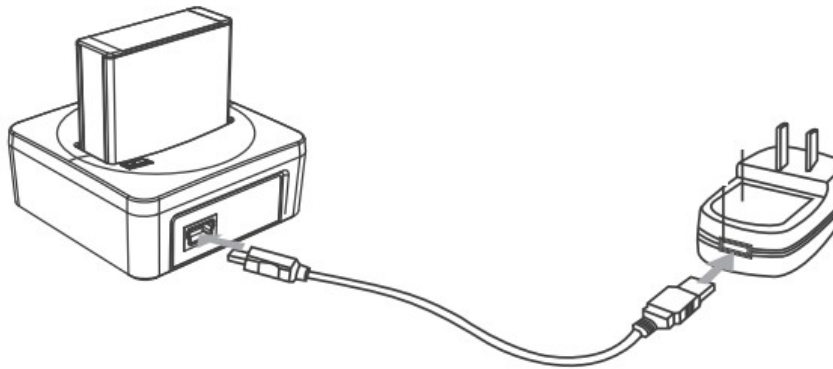

★ As we are committed to constantly improving our products, some details may not be in conformity with the actual products. Please accept our understanding for the inconvenience caused by the actual products.